

7UHQFK 026 %DUULHU 6FKRWWN\ 5H

Features

- ‡ \$GYDQWUHQFK WHFKQRORJ\
- ‡ /RZRUZDWRGWDJH GURS
- ‡ /RZRZURVVHV
- ‡ +LJHILFLHQF\ RSHUDWLRO
- ‡ /HDGHLQLVK &RPSOLDQW

763 / \$)

SMAF

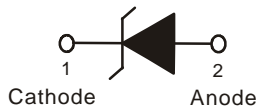

Applications

- ‡ '&' & RQYHUWHUV
- ‡ \$&' & GDSWRUV
- ‡ 6ZLWFKRZHSXSSOLHV
- ‡)UHHZKHHLRGLJ

Maximum ratings and electrical characteristics (T_J = 25°C unless otherwise noted)

3DUDPHWHU		6\PERO	/LPLW	8QLW
0D[LPXPHSHVSHUNYHYURQHW DJH		9550		9
0D[LPXPHYHURJHZDUG UFXEWHIQWG		,) \$9		\$
3HDN IRVZDUEBUUHQW VLQDQH ZDYH VXSHULPSRVHGRFSGUDRCHG		,)60		\$
2SHUDMXQDQGRQWRUDJH WHPSHUDW		XOH 06DJH	WR	f&
7\SLFDO WKHUPDO UHVLVWDQFH SHU ORXQWHG RQ)5 3&%		GLRGH 5\$-&		f& :
,QVWDQWDQHRXV IRUZDUGS YRQWDJH		9)	7<3	0\$;
	,) \$		7- f&	
,QVWDQWDQHRXV UHVRUQWH UDWHYHYURQHW DJH		,5		X\$
			7- f&	

1RWHV

3XOVH WHVVSXOVH ZLGWK GXW\F\FOH

3XOVH WHVW 3XOVH ZLGWK 0

RATINGS AND CHARACTERISTICS CURVES

7\$

f & XQOHVQRWKBUZLVH

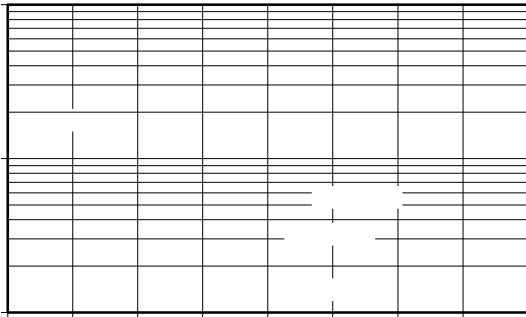
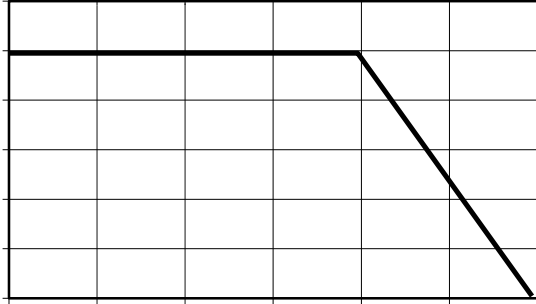

ODUNLQJ ,QIRUPDWLRQ

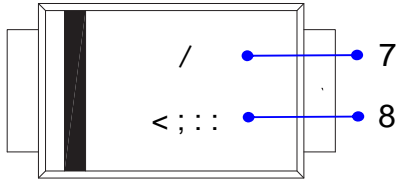

73URGXFW PRGH \$) LV DEEUHYLDW
83' & LQIRUPDWLRQ

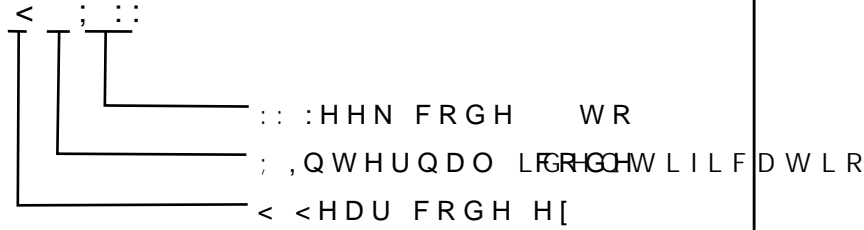

3DFNDJLQJ ,QIRUPDWLRQ

5HHO 'LPHQVLRQV

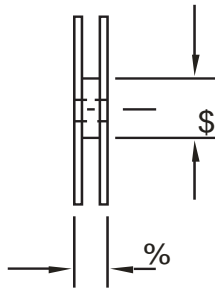
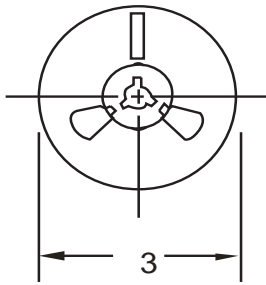

,QVLGH %R[

2XWVLGH %R[

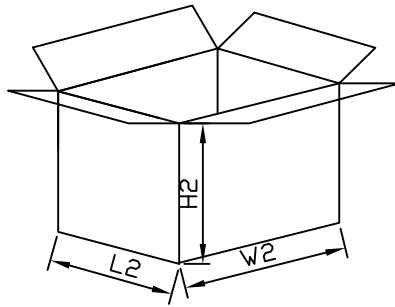
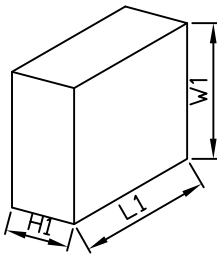

3DFNDJLQJ ,QIRUPDWLRQ

12	81,	5HHO 'LPHQVL	,QVLGH	2XWVLGH %R[
----	-----	--------------	--------	-------------

& \$ % / : + / : +

6L]H PP

4 - -IGd 3Ó4 4Gd 7C yVA c3-4 @ á G@C@C@CH %3>iü#.<# 308@52E@WD#>4 |GPe1s G\$Ö.#0`k#<12CAvUP`>á