

7UHQFK 026 %DUULHU 6FKRWWN\ 5H

)HDWXUHV

‡ \$GYDQWUHQFK WHFKQRORJ\
 ‡ /RZRUZDURGDWDJH GURS
 ‡ /RZRZURVVHV
 ‡ +LJHILFLHQF\ RSHUDWLRQ
 ‡ /HDGH)HLQLVK &RPSOLDQW

\$SSOLFDFWLRQV

‡ '& '& &RQYHUWHUV
 ‡ \$& '\$GDSWRUV
 ‡ 6ZLWFKRZHS\$SSOLHV
 ‡)UHHZKH'HLRGLJ

0D[LPXP UDWLQJV DQG HOHFWULFDJ&FXODDPRVHJQRVWHIGFV

3DUDPHWHU		6\PERO	/LPLW	8QLW
0D[LPXPHSHVSHUNYHYURQWDJH		9550		9
0D[LPXPYHURJHZDUG UHJHWHIQWG		,) \$9		\$
3HDN IRUZDURSUHQW VLQRDQZDYH VXSHULPSHQHGRSGLRGH		,)60		\$
2SHUDMXQRDQRWRUDJH WDRSHUDW		XUH 767	WR	
7\SLFDO WKHUPDO UHVLVWDQFH SHU		GLRSH ORXQWHG RQ)5	3&f% :	
,QVWDQWDQHRROWRDUG SHGLRGH	,) \$	7- f&	7<3	0\$;
	,) \$	7- f&		
	,) \$	7- f&		9
,QVWDQWDQHRXUHQHURQW UDWHYHURQWDJH	,) \$	7- f&		X\$
	,) \$	7- f&		P\$

1RWHV

3XOVH WHVVSXOVH ZLGWK GXW\FFOH
 3XOVH WHVW 3XOVH ZLGWK 0

5 \$ 7 , 1 * 6 \$ 1 ' & + \$ 5 \$ & 7 (5 , 6 7 , & 6 & 7 8 5 9 (6 f & X Q O H V Q R W K B U Z L V H

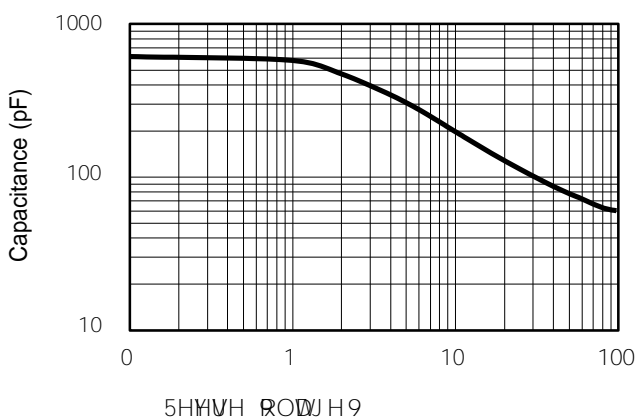
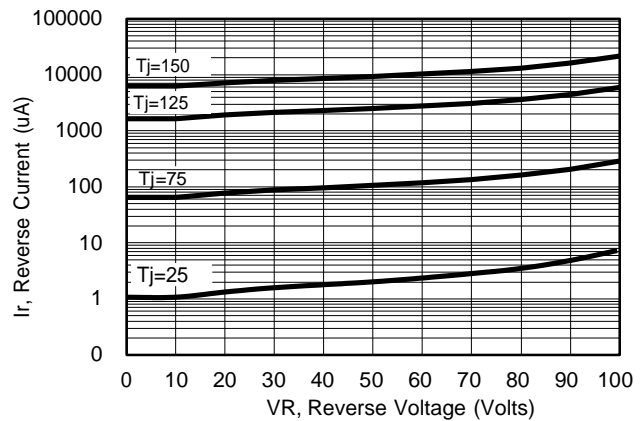
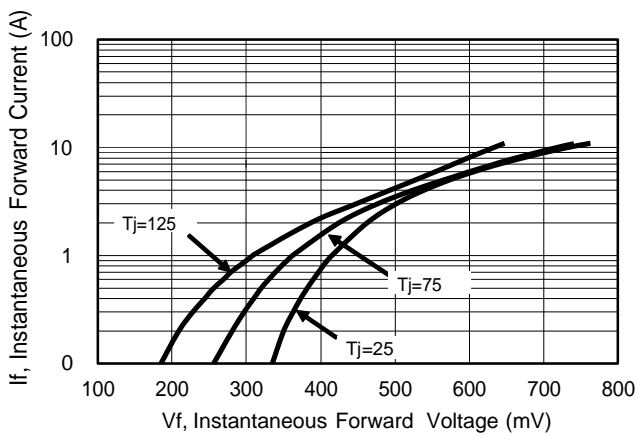
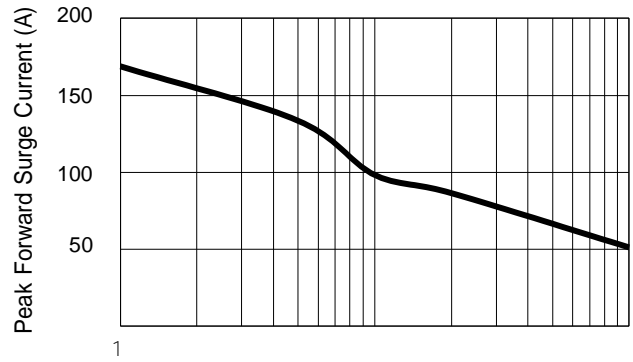
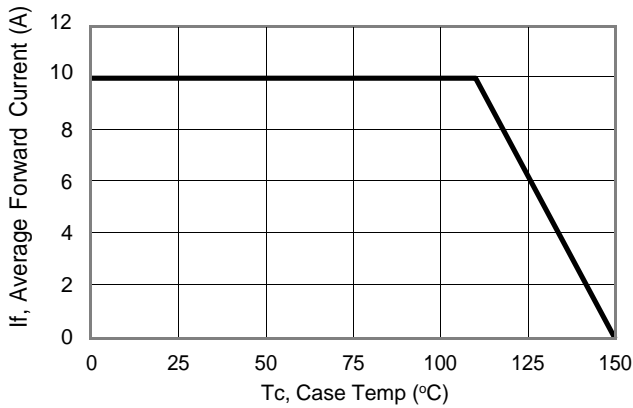

3 \$ & . \$ * (287 / , 1 (' , 0 (16 , 2 1 6

72

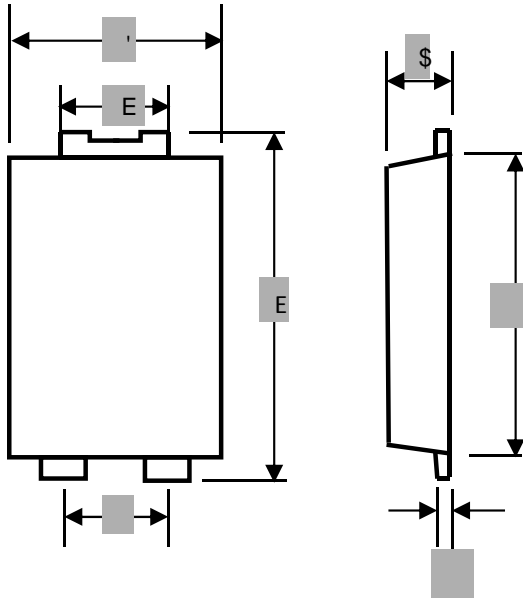

0DUNLQJ ,QIRUPDWLRQ

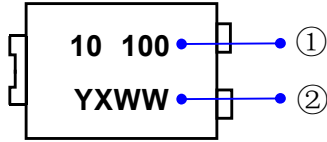

① 3URGXFW PRGHO 763 / 63 5HIHUL
WR DV \$

② 3' & LQIRUPDWLRQ

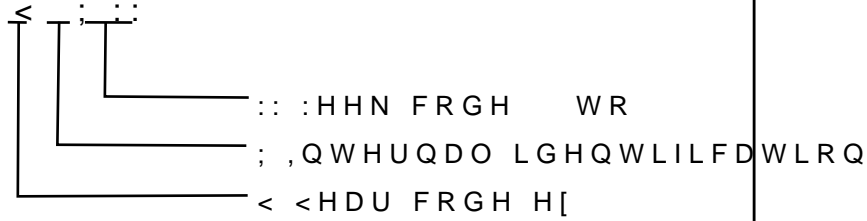

3DFNDJLQJ ,QIRUPDWLRQ

5HHO 'LPHQVLRQV

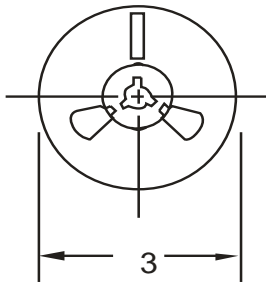

,QVLGH %R[

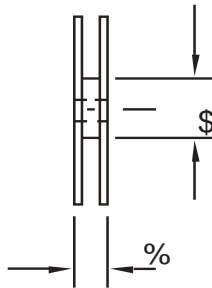

2XWVLGH %R[

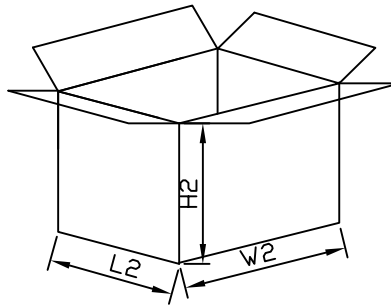
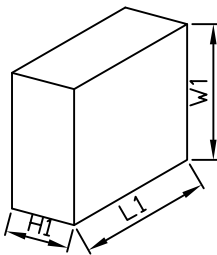

3DFNDJLQJ ,QIRUPDWLRQ

12	81,	5HHO 'LPHQVLR			,QVLGH %R[2XWVLGH %R[
6L]H	PP	\$			L1	1	1	L		
				1						
					1					
					1 1		1 1	1		