

6FKRWWN\ %ULGJH 5HFWLILHU

0D[LPX5PDWLQ0G0HFWBKDD0FWHULVWLFV  
5DWLQWf &DPELMQHW SHUXDQXUMKHUZSLHFLILHG



RATINGS AND CHARACTERISTICS CURVES

)LJ \$YHUDJH 5HFWLILHG 2XWSXW &XUHHQW )LJ 7\SLFDO 5HYHUVH &KDUDFWHULVWLFV  
'HUDWLQJ &XUYH

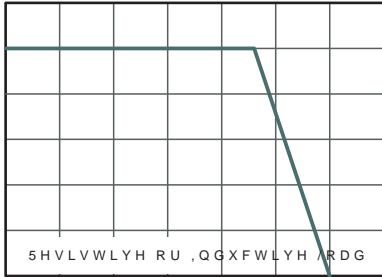

&DVH 7HPSHUDWXUH °&

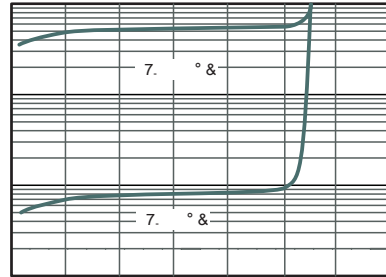

SHUFHQW R3IHDDW5HG YHUVH 9ROWDJH

)LJ 7\SLFDO ,QVWDQHRXV )RUZDUG &KDUDFWHULVWLFV

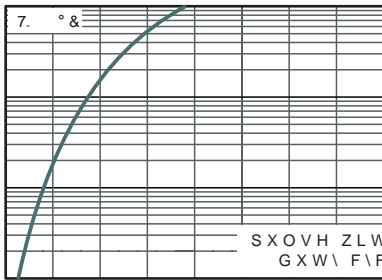

,QVWDQHRXV )RUZDUG 9ROWDJH 9

)LJ 7\SLFDO -XQFWLRQ &DSDFLWDQFH

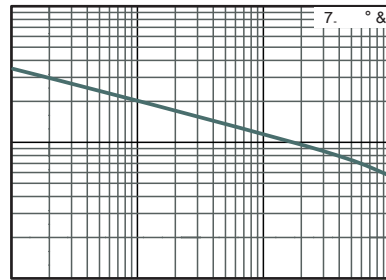

5HYHUVH 9ROWDJH 9

)LJ 0D[LPXP 1RQ 5HSHWLWLYH 3HDN )RUZDUG 6XUDJH &XUHHQW

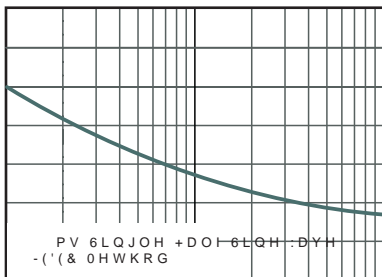

1XPEHU RI &\FOHV



06%PHFKDQGLFWD

81,7		\$	&	'	(	(	/	H	E	
PP	PD[									<i>f</i>
	PLQ									
PLO	PD[									
	PLQ									

06%6XJJHVVHG 3DG /D\RXW

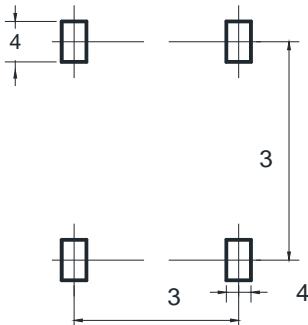

81,7		3	3	4	4
PP	PLQ				
PD	PLQ				

'LPHQVILR/QR/LOOLPHWHUV

0DUNLQJ ,QIRUPDWLRQ

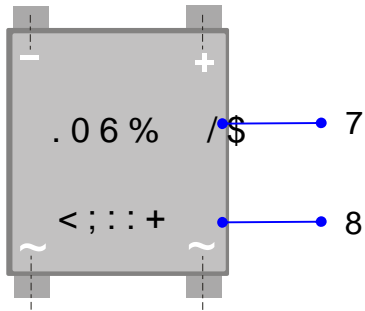

7 3URGXFW PRGHO .06% / \$  
8 3' & LQIRUPDWLRQ

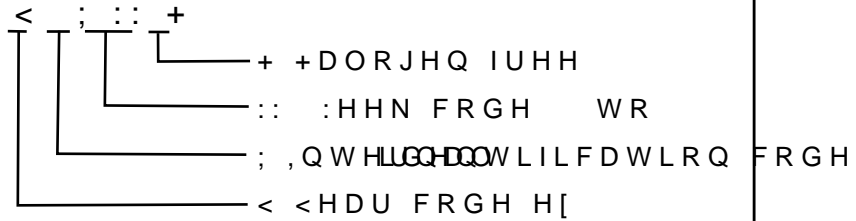

3DFNDJLQJ ,QIRUPDWLRQ

5HHO 'LPHQVLRQV

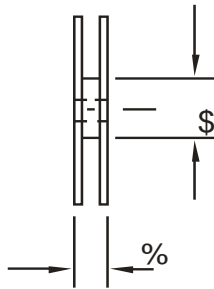
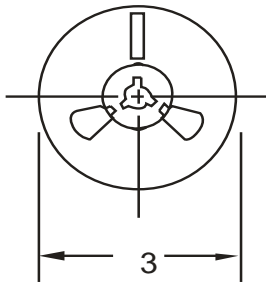

,QVLGH %R[

2XWVLGH %R[

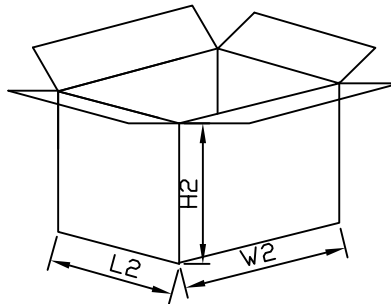
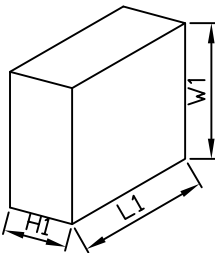

3DFNDJLQJ ,QIRUPDWLRQ

12	81,	5HHO 'LPHQVLR			,QVLGH %R[			2XWVLGH %R[		
			\$	%	/	:	+	/	:	+
6L]H	PP									
47<	3&6	6PDOGDFW DJH3&6 UHHO			3&6 UHHO RWDO			3&6 FDUERLQ RWDO		
1RWH		7ROHUDQFH PP" PP			PP" PP			PP" PP		